



**TRANSMISSION CROSSARM
 DRILLING GUIDE – 115kV
 098.100**

Originator: J. Flader

Standards Approval:
 Jeff Flader

Approval: J. Flader

Date: 3/17/2014

Revision: 1

Stds Committee Approval:
Approved

Description	Stock Number
Wood Crossarm Specifications Transmission Standard Practice	06322
Wood Crossarm Specifications Transmission Standard Practice	80200
Wood Crossarm Specifications Transmission Standard Practice	80235
Wood Crossarm Specifications Transmission Standard Practice	80240
Wood Crossarm Specifications Transmission Standard Practice	80250
Wood Crossarm Specifications Transmission Standard Practice	80260
Wood Crossarm Specifications Transmission Standard Practice	80300
Wood Crossarm Specifications Transmission Standard Practice	80350
Wood Crossarm Specifications Transmission Standard Practice	80356
Wood Crossarm Specifications Transmission Standard Practice	80580



WOOD CROSSARM SPECIFICATIONS

Transmission Standard Practice

098.100

STOCK NO. 006322

Originator:
J. Flader

Standards Approval:
Jeff Flader

Approval:

Date:
3/17/2014

Rev #:
1

Revision Description:
NEW DRAWING

TOP

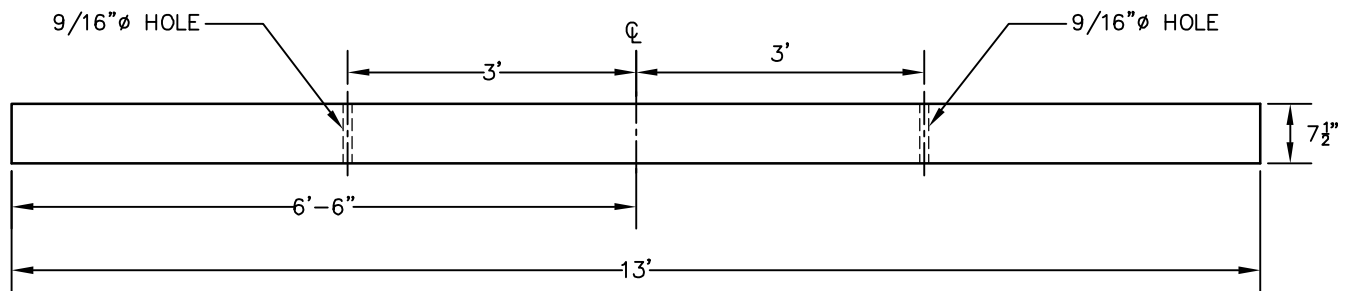

FRONT

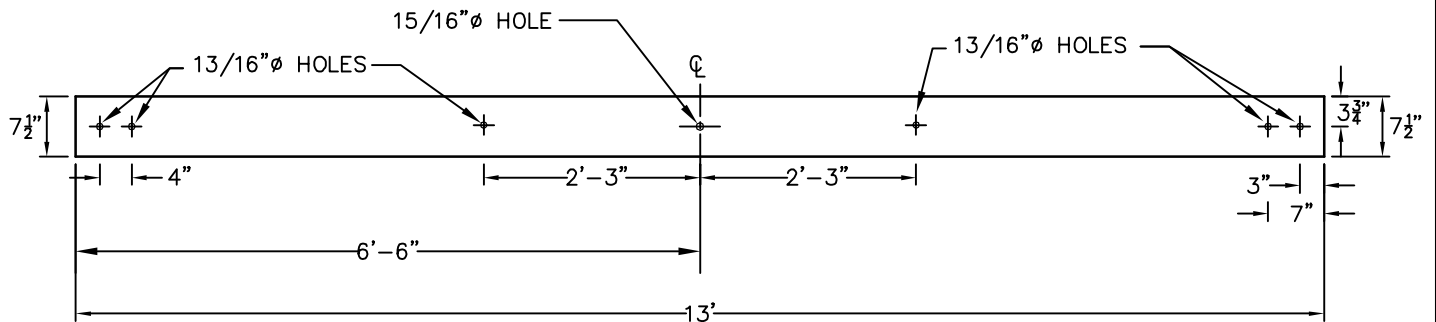

CROSSARM: 7 1/2" x 7 1/2" x 13'-0" FOR CDE STRUCTURE
STOCK NO. 006322



WOOD CROSSARM SPECIFICATIONS

Transmission Standard Practice

098.100

STOCK NO. 80200

Originator:
J. Flader

Standards Approval:
Jeff Flader

Approval:

Date:
3/17/2014

Rev #:
1

Revision Description:
NEW TITLE BLOCK

TOP

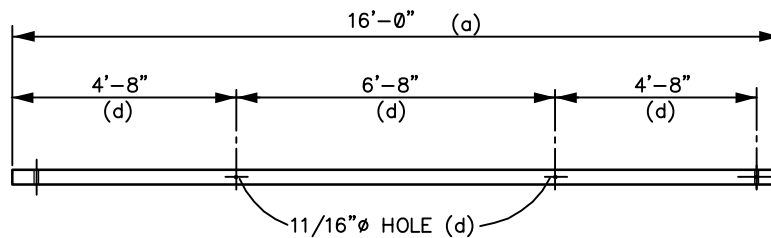

FRONT

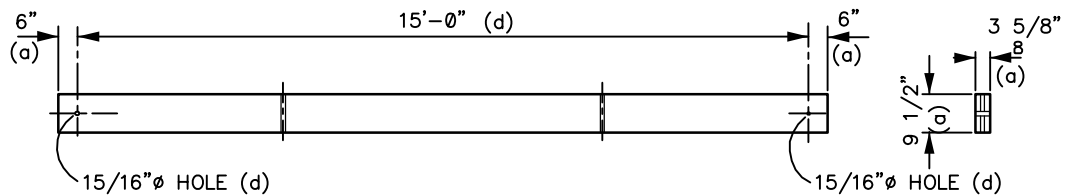

CROSSARM 3 5/8" x 9 1/2" x 16' FOR TYPE G, GA, TPA STRUCTURES
STOCK No.80200



WOOD CROSSARM SPECIFICATIONS

Transmission Standard Practice

098.100

STOCK NO. 80235

Originator: **JF**

Standards Approval: **Jeff Flader**

Approval:

Date: **3/17/2014**

Rev #:
1

Revision Description:
NEW TITLE BLOCK

TOP

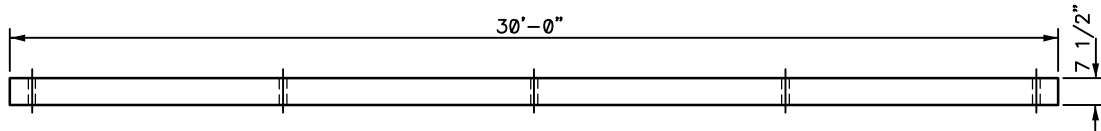

FRONT

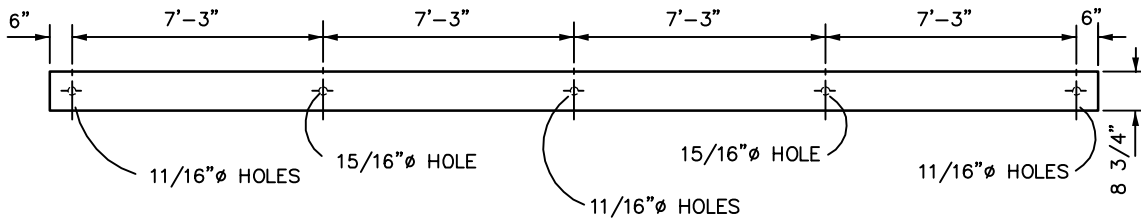

CROSSARM 7-1/2" x 8-3/4" x 30' AP
STOCK No. 80235



WOOD CROSSARM SPECIFICATIONS

Transmission Standard Practice

098.100

STOCK NO. 80240

Originator:
J. Flader

Standards Approval:
Jeff Flader

Approval:

Date:
3/17/2014

Rev #:
1

Revision Description:
NEW TITLE BLOCK

TOP

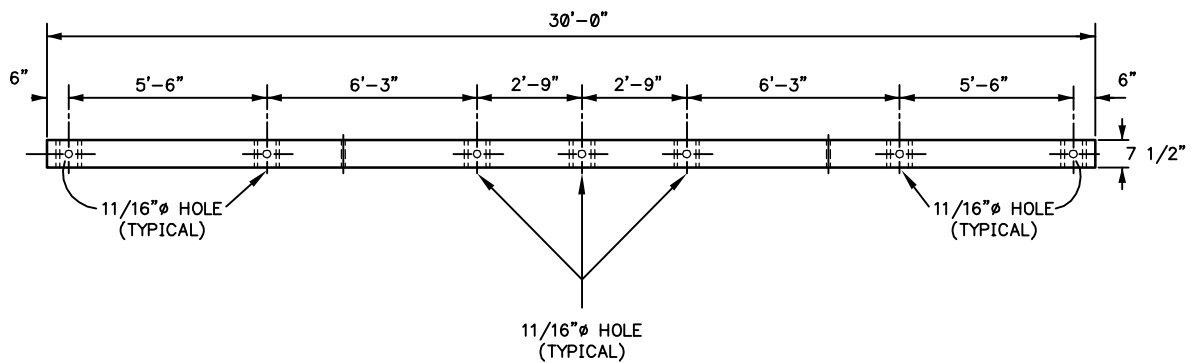

FRONT

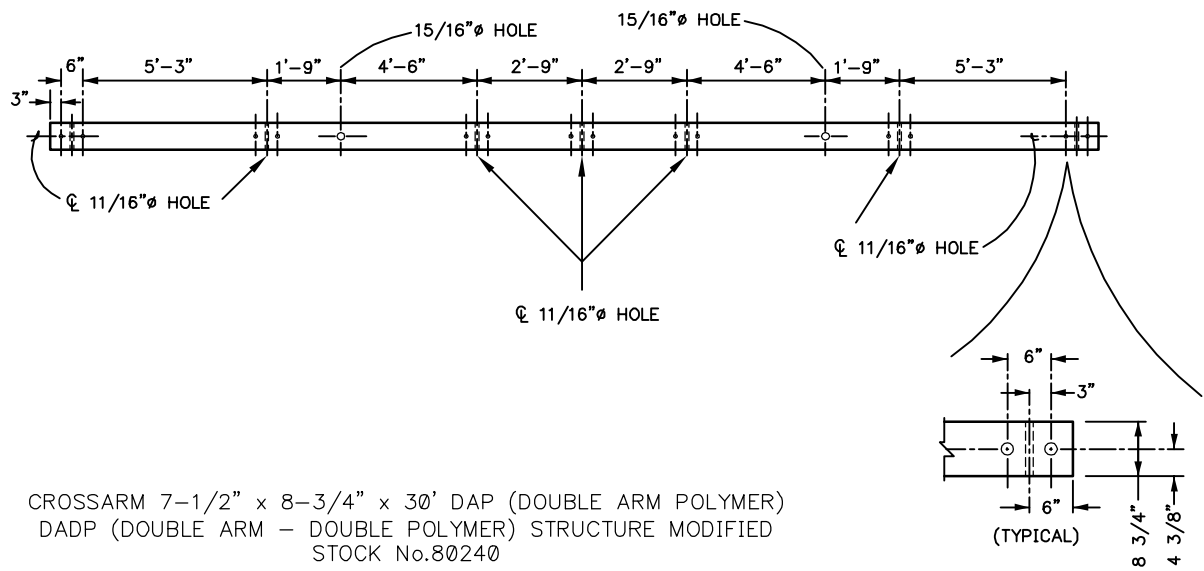

CROSSARM 7-1/2" x 8-3/4" x 30' DAP (DOUBLE ARM POLYMER)
 DADP (DOUBLE ARM - DOUBLE POLYMER) STRUCTURE MODIFIED
 STOCK No. 80240



WOOD CROSSARM SPECIFICATIONS

Transmission Standard Practice

098.100

STOCK NO. 80250

Originator:
J. Flader

Standards Approval:
Jeff Flader

Approval:

Date:
3/17/2014

Rev #:
1

Revision Description:
NEW TITLE BLOCK

TOP

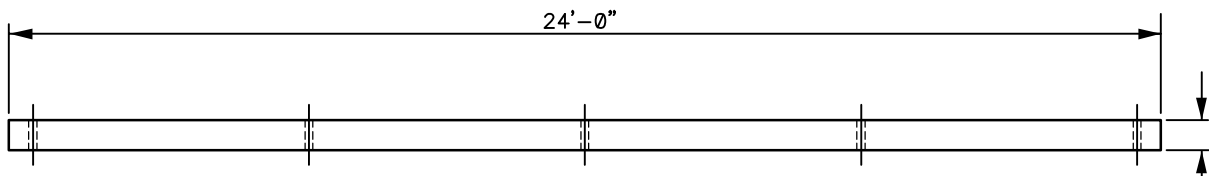

FRONT

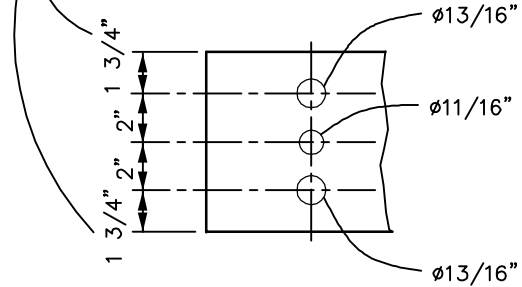
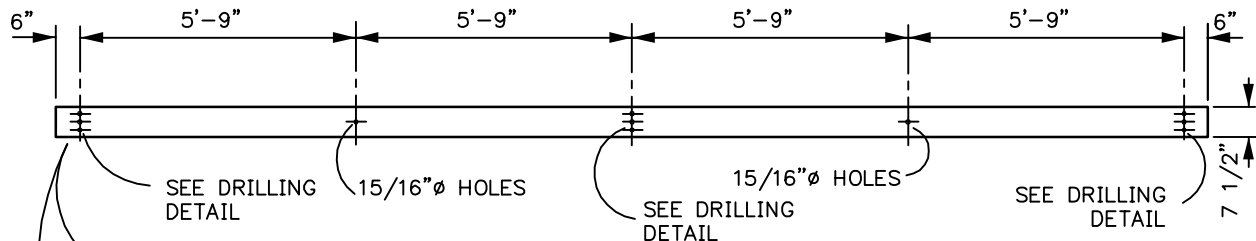

DRILLING DETAIL
TYP. 3 PLACES

CROSSARM 7-1/2" x 7-1/2" x 24' A & E
STOCK No.80250



WOOD CROSSARM SPECIFICATIONS
Transmission Standard Practice

098.100
STOCK NO. 80260

Originator:
J. Flader

Standards Approval:
Jeff Flader

Approval:

Date:
3/17/2014

Rev #:
1

Revision Description:
NEW TITLE BLOCK

TOP

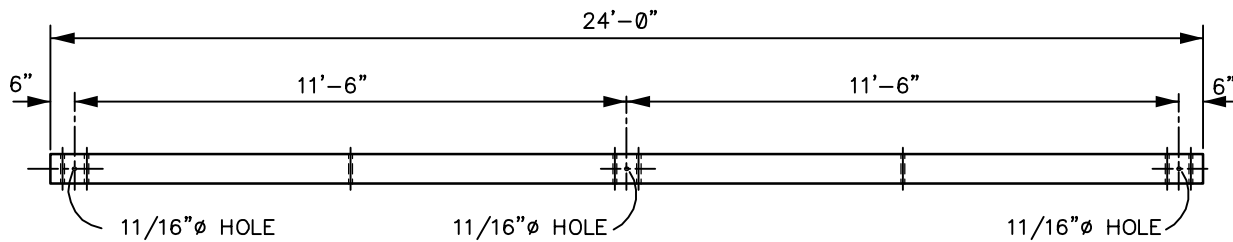

FRONT

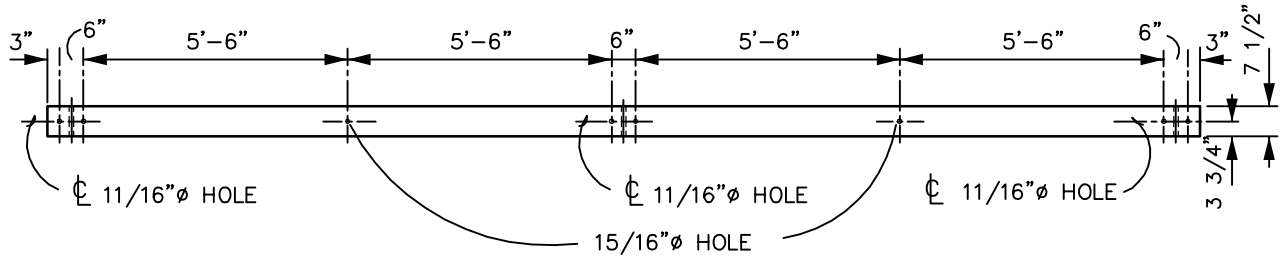

CROSSARM 7-1/2" x 7-1/2" x 24' TYPE DA STRUCTURE
STOCK No.80260



WOOD CROSSARM SPECIFICATIONS

Transmission Standard Practice

098.100-18

STOCK NO. 80300

Originator:
J. Flader

Standards Approval:
Jeff Flader

Approval:

Date:
3/17/2014

Rev #:
1

Revision Description:
NEW TITLE BLOCK

TOP

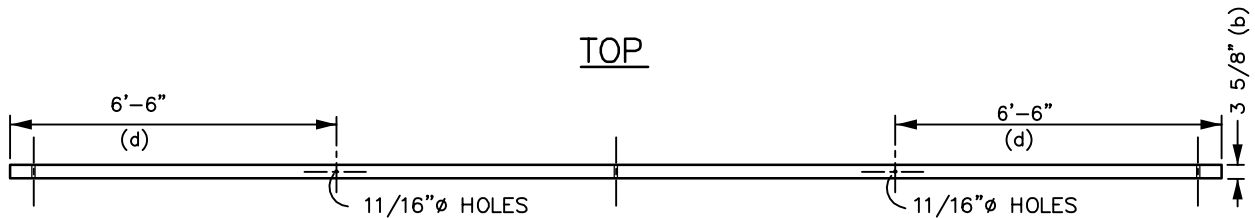

FRONT

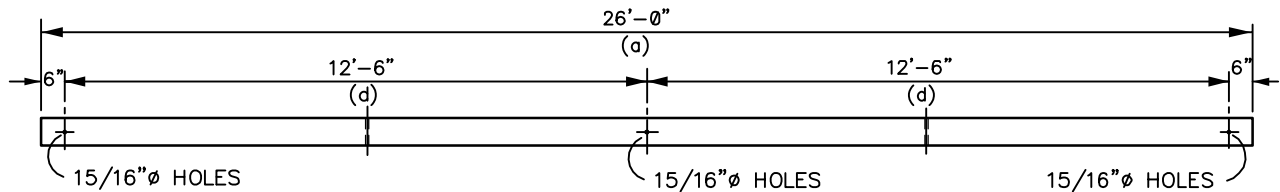

CROSSARM 3-5/8" X 9-1/2" X 26' TYPE D, F, HORIZONTAL SWITCH, T
STOCK No.80300



WOOD CROSSARM SPECIFICATIONS

Transmission Standard Practice

098.100

STOCK NO. 80350

Originator:
J. Flader

Standards Approval:
Jeff Flader

Approval:

Date:
3/17/2014

Rev #:
1

Revision Description:
NEW TITLE BLOCK

TOP

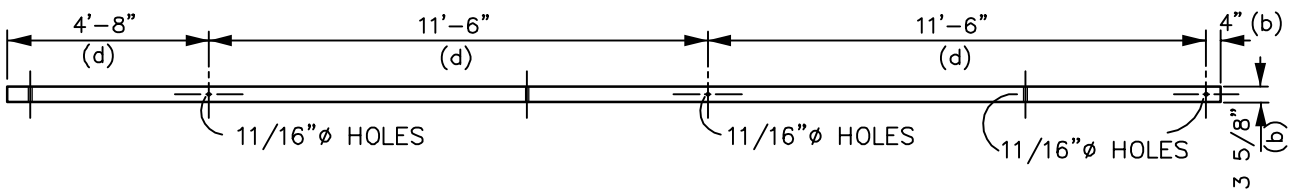

FRONT

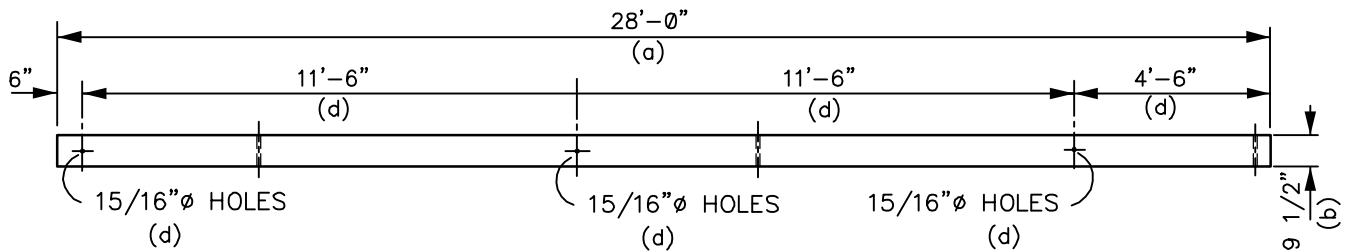

CROSSARM 3-5/8" x 9-1/2" x 28' TYPE G2, G2A & T STRUCTURES
STOCK No.80350



WOOD CROSSARM SPECIFICATIONS

Transmission Standard Practice

098.100

STOCK NO. 80356

Originator: **JF**

Standards Approval: **Jeff Flader**

Approval:

Date: **3/17/2014**

Rev #:
0

Revision Description:
NEW DRAWING

TOP VIEW

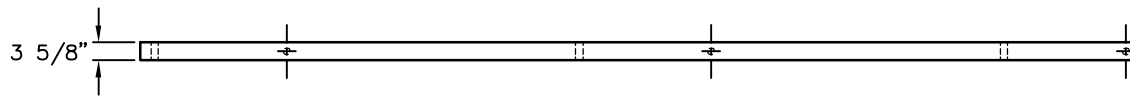

FRONT VIEW

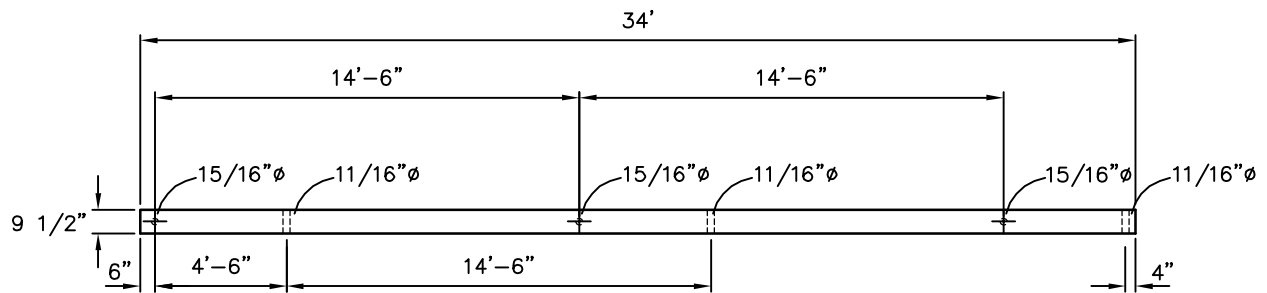

CROSSARM: 3-5/8" x 9-1/2" x 34'
TYPE G2P & G2AP STRUCTURES
STOCK No. 80356

- Construction Standards -

098.100-25

CHELAN COUNTY
PUBLIC UTILITY DISTRICT

Owned By The People We Serve



WOOD CROSSARM SPECIFICATIONS

Transmission Standard Practice

098.100

STOCK NO. 80580

Originator:
J. Flader

Standards Approval:
Jeff Flader

Approval:

Date:
3/17/2014

Page 25 of 25

Rev #:
1

Revision Description:
NEW TITLE BLOCK

FRONT

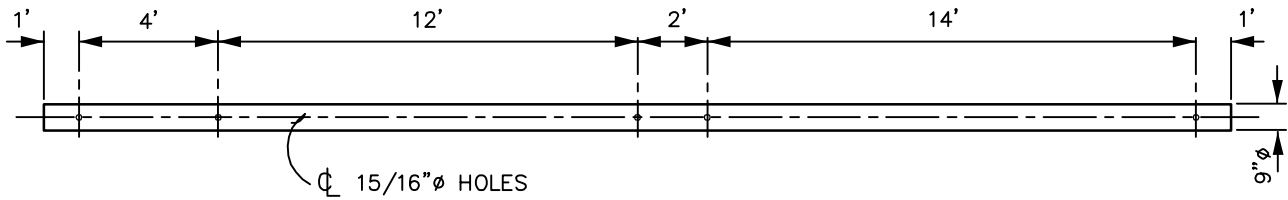

ROUND CROSSARM 9" ϕ x 34"
STOCK No. 80580